

Resistors and Ohm's Law

Applied Mechatronics

First Grade Level

Wolfgang Neff

Resistors (1)

- Who stands in the way?

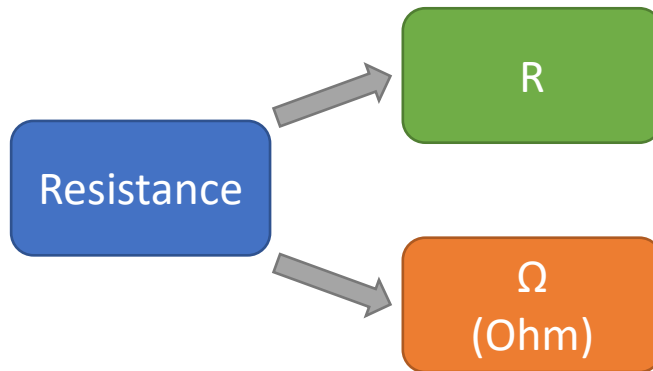
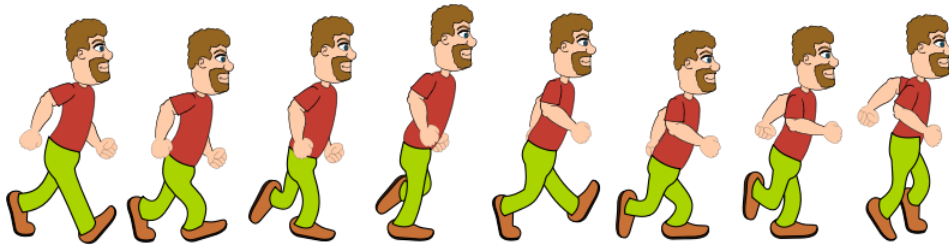

Resistors (2)

- Someone holds me up

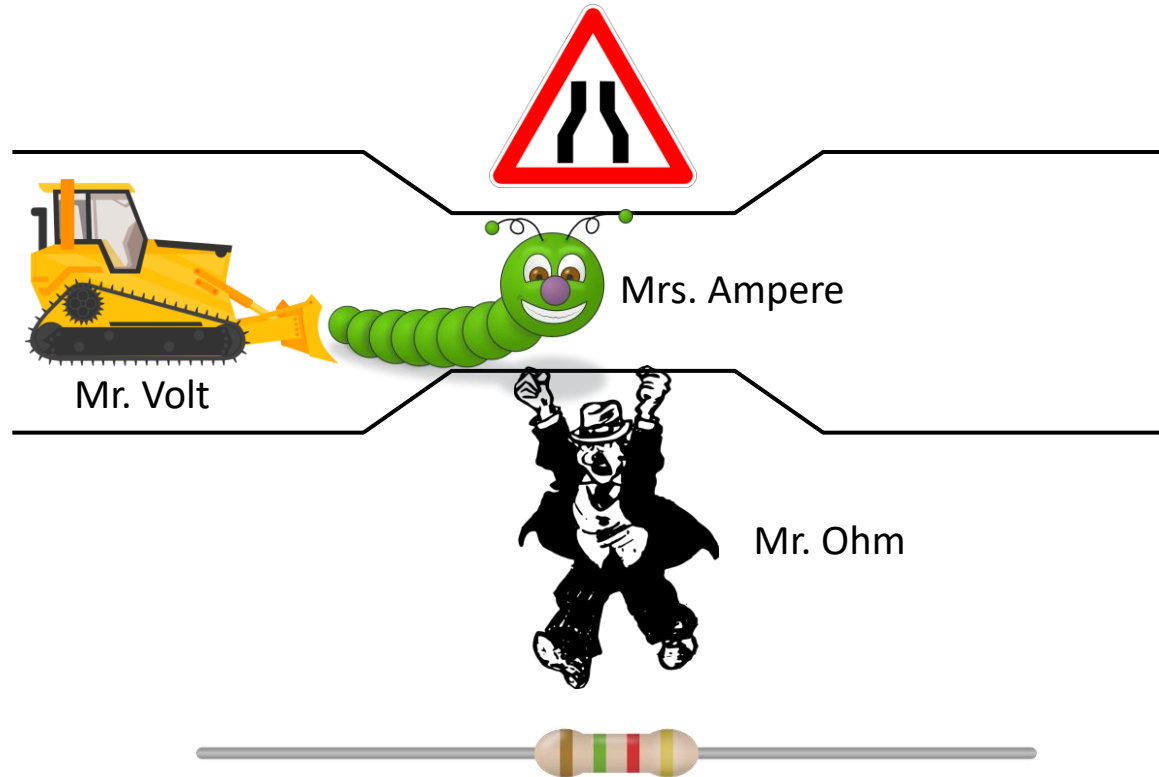

Resistors (3)

- Electricity comes into play

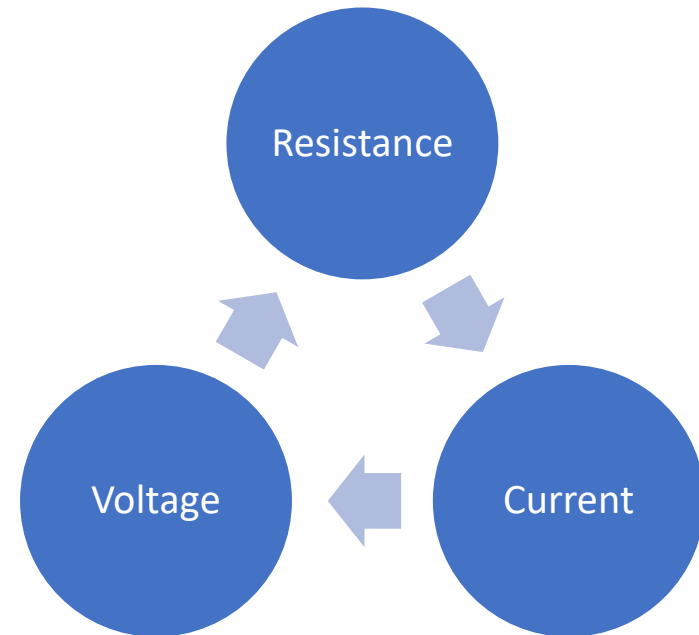
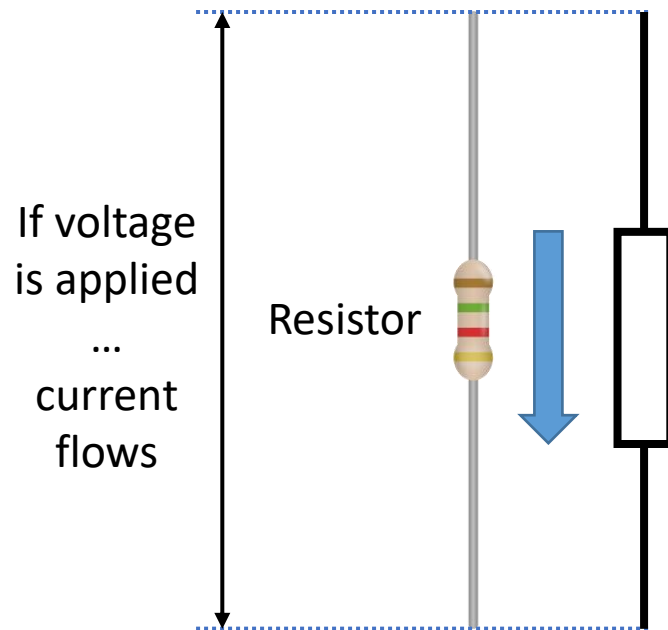

Ohm's Law (1)

- What does Mr. Ohm say?

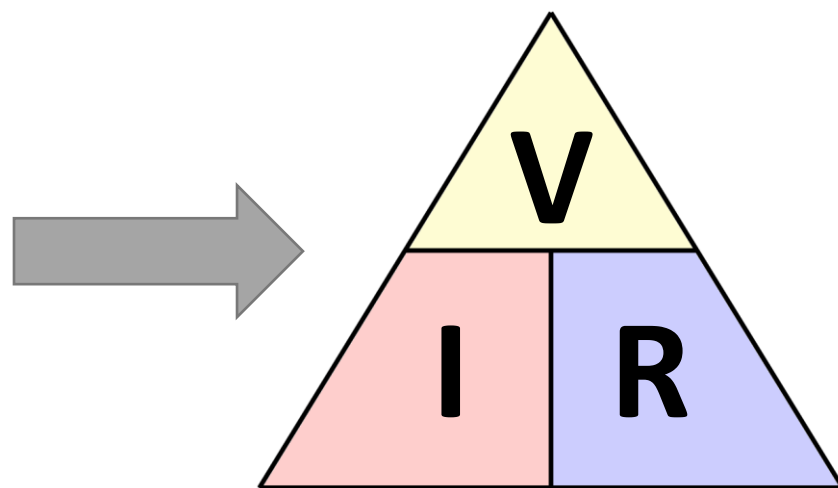

Ohm's Law (2)

- What can I do for you?

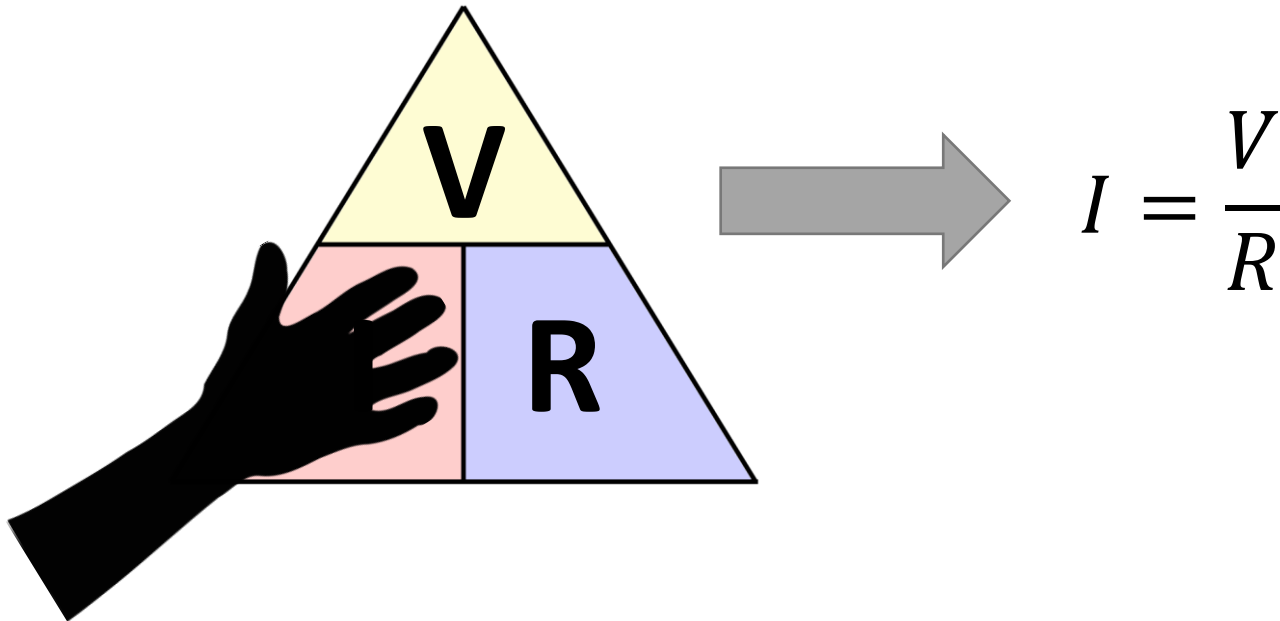

Ohm's Law (3)

- What can I do for you?

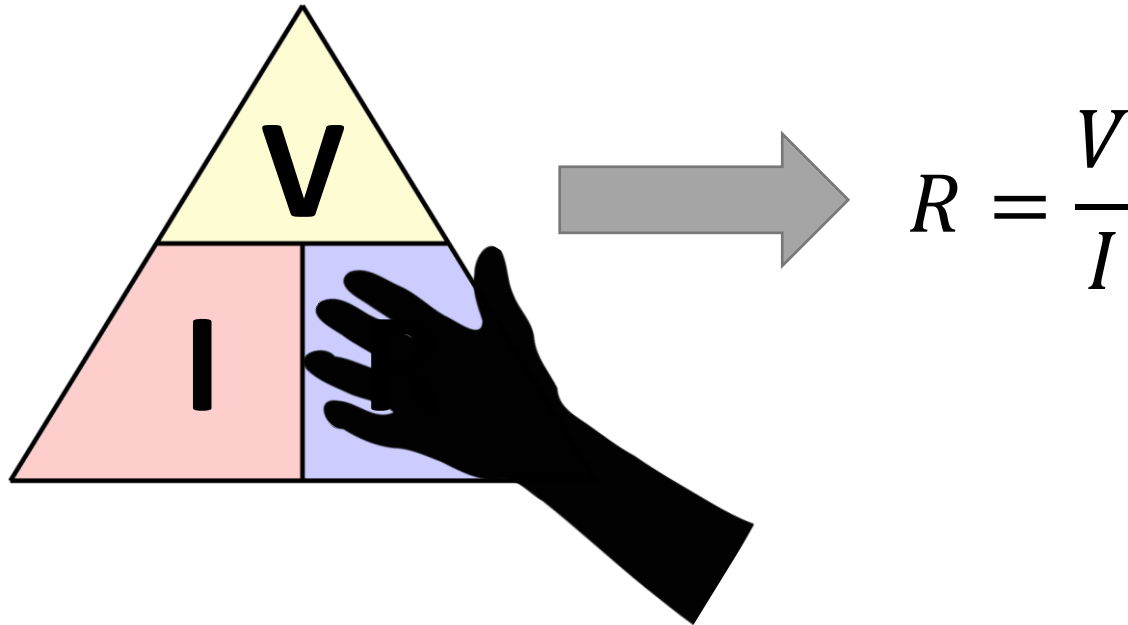

Ohm's Law (4)

- What can I do for you?

